



**Dehler** 

**42**



**Dehler** 

42

VALUES

# A TRUE DEHLER

**Eine Yacht – wie die Dehler 42 – kann man nur bauen, wenn man durch und durch Segler ist.**

Nur wer sein Leben diesem wunderbaren Sport gewidmet hat, bleibt seinen eigenen Werten treu – und entwickelt jede Yacht mit derselben Hingabe, Innovationskraft und Präzision. Wir bei Dehler machen das so seit über 50 Jahren.

**To build a yacht like the Dehler 42, you have to be a sailor through and through.**

Only those who dedicate their life to this wonderful sport will always stay true to their values and develop each yacht with equal commitment, innovative power and precision. At Dehler, we have been doing this for more than 50 years.





## VALUES

# PERFECTION IS BASED ON EXPERIENCE

Ein neues Dehler Modell ist erst vollendet, wenn es nichts mehr zu optimieren gibt. Bis dahin fließt unsere ganze Erfahrung aus Jahrzehnten Konstruktionsarbeit, tausenden Yachten und kontinuierlichen Innovationen in die Entwicklung mit ein.

The creating process of a new Dehler model is only completed once there is nothing left to improve. Up to this point, all the experience we gained from decades of design work, thousands of yachts and continuous innovations is incorporated into the development.

# 25,434 YACHTS

have been delivered by Dehler since 1963 – an experience that results in excellence.

# 859 INNOVATIONS

that made sailing and living onboard significantly more enjoyable were invented by Dehler.

# 63 MODELS

in all sizes up to 60 feet were created by our designers and developers.

MORE THAN  

# 50 YEARS

of yacht building have continuously increased the demands we place on ourselves and made us one of the leading sailing boat manufacturers.

# 1 PROMISE

follows from all we achieved until today: to build the one Dehler 42 you wish for.





## VALUES

# DEHLER 42

## FULL OF IDEAS

### MORE SPEED

- | Maximized sail area
- | judel/vrolijk & co designed performance hull
- | Light-weight construction
- | Competition options available

### PERFECT QUALITY

- | Vacuum infusion hull lamination
- | Durable & reliable materials installed
- | Hand-laid teak deck with vacuum bonded wood

### HIGHEST SAFETY

- | High righting moment
- | Dehler hull/deck joint
- | Dehler Carbon Cage

### INTELLIGENT FUNCTIONALITY

- | Sliding chart table
- | Mainsheet traveller
- | Dehler Uni Door Concept

### OUTSTANDING DESIGN

- | Distinctive window lines
- | Sleek and elegant profile

### BEST RESALE VALUE

- | Made in Germany
- | Timeless elegance
- | Global customer support

### STRONG INNOVATIONS

- | Carbon reinforcement in the bottom structure
- | German Mainsheet System
- | Integrated plotter pods in coamings
- | Under deck furler
- | Recessed cockpit seats





# OUR VALUES

In unserem Streben nach der idealen Yacht lassen wir uns von drei klaren Werten leiten. Diese Werte haben uns einst zu den Pionieren im deutschen GFK-Bootsbau gemacht – und sie stecken noch heute in jeder Dehler, die unsere Werft verlässt.

Our passion for creating the perfect yacht is based on three clear values. These values made us a pioneer in German GRP boat building and can be found today in every Dehler leaving our shipyard.

engineered  
by **Dehler** 

## Value No. 1

### PROCEED WITH SPEED

Für uns gehört Segelleistung zu den wichtigsten Tugenden einer Yacht. Warum? Weil es immer wieder begeistert, die Kraft zu spüren, mit der der Bug rasant die Wellen durchschneidet. Und um Begeisterung geht es beim Segeln nun einmal. Deshalb haben auch unsere komfortablen Yachten immer Sport-Genie.

For us, sailing performance is one of a yacht's most important qualities. Why? Because it is incredible fun to feel the force the bow exerts when cutting through the waves at a terrific pace; and sailing is simply about having fun. That's why our comfortable yachts have always sports in their DNA, too.

## Value No. 2

### SMART PERFECTION

Eine perfekte Yacht ist schnell, sicher und schön. Die Ausstattung lässt keine Wünsche offen. Im Design verschmilzt Funktion mit Ästhetik und die Verarbeitung ist makellos bis ins kleinste Detail. Diesen hohen Ansprüchen fühlen wir uns bei Dehler täglich verpflichtet. Wir bauen jede Yacht so, dass Sie beeindruckt sind von den vielen cleveren Ideen. Wenn alle Lösungen ganz einfach aussehen, obwohl es harte Arbeit war, dann ist es „Smart Perfection“.

A perfect yacht is fast, safe and beautiful. Its features meet any desire a sailor might ever have. Its design blends functionality with aesthetics, and the workmanship is flawless, right down to the smallest detail. These are the high standards we are committed to, striving to meet them every day. We build each yacht in such a way that you will be impressed by lots of clever ideas. 'Smart Perfection' is when solutions seem really simple although hard work has been put into them.

## Value No. 3

### GERMAN ENGINEERING

Dehler steht für die Werte, die „Made in Germany“ zu dem Gütesiegel gemacht haben, das es bis heute ist. Vor allem zählt für uns Gründlichkeit. Präzision in jedem Detail prägt unser Denken und Handeln sowie die Wahl unserer Partner. Dazu gehören vor allem die international renommierten Yacht-Konstrukteure judel/vrolijk & co. Sichtbar wird dies in zeitlosen Formen mit dynamisch-eleganten Linien.

Dehler justifies values that turned 'Made in Germany' into the seal of approval that it is today. Thoroughness counts before everything else. Precision in every detail is what shapes the way we think and act as well as who we choose to be our partners. Most notably, the internationally renowned yacht designers judel/vrolijk & co belong to our partners. Timeless shapes with dynamic, elegant lines are testimony to all of this.





DEHLER 42

# CONTENT INHALT

## VALUES

2 A TRUE DEHLER

4 PERFECTION IS BASED ON EXPERIENCE

6 DEHLER – FULL OF IDEAS

8 OUR VALUES

## INDIVIDUALITY

12 IT'S UP TO YOU

14 EASY TO SAIL

15 HARD TO BEAT

16 COMPETITION & CRUISING STYLE

62 PACKAGES

64 OPTIONS

## EXTERIOR

20 DECK

24 HULL

30 TECHNICAL SPECIFICATIONS

32 MATERIALS & COLOURS

## INTERIOR

40 SALOON & PANTRY

46 MASTER & GUEST CABIN

48 CABIN LAYOUTS

50 MATERIALS & COLOURS

## TECHNOLOGY

27 CARBON RIG

28 DEHLER CODE ZERO

58 DEEPER INSIDE



INDIVIDUALITY

# IT'S UP TO YOU

**Die Dehler 42 ist wandelbar**, wie ein Chamäleon. Fahrtenschiff, Performance-Cruiser, Regatta-Yacht: Ihre Fahrleistungen lassen sich nach Belieben steigern und passen sich Ihrem Segelstil an. Auch unter Deck stehen Ihnen alle Möglichkeiten offen. Hier löst eine Vielfalt an Kabinenlayouts und Materialien unser Versprechen ein: Die Dehler ist immer das, was Sie daraus machen.

**The Dehler 42 is as changeable** as a chameleon. Touring yacht, performance cruiser, regatta racer – her speed performance can be increased as you like and adapts completely to your personal sailing style. Even below deck, all options are open. Offering a huge variety of cabin layouts and materials, we keep our promise: the Dehler is whatever you make it.



*Our idea was to create a performance cruiser in the best sense of the word – a yacht covering the whole range of sailing pleasures from great convenience to high speed. So we faced the big challenge to make sure that any of its possible versions would be absolutely convincing. Now we are proud to state the Dehler 42 will definitely become whatever the owner considers as the ultimate sailing yacht.*

*Torsten Conradi, Managing Director of judel/vrolijk & co*



## INDIVIDUALITY

# EASY TO SAIL

**Höchster Segelkomfort gehört bei einer Dehler zur Grundausstattung.** Bestes Beispiel: das German Mainsheet System. Die beiden Enden der Großschot werden auf getrennte Winschen gelegt. So haben Sie die Schot auf beiden Cockpitseiten in unmittelbarer Reichweite. Ohne Ihren Steuerstand zu verlassen, behalten Sie volle Kontrolle über das Segel.

**On a Dehler, great sailing comfort is part of the basic equipment.** It comes, for example, with the German Mainsheet System: both ends of the mainsheet are taken to separate winches. Now the sheet is within immediate reach on each side of the cockpit. You will always maintain full control of the mainsail without leaving the helm.



# HARD TO BEAT

**Ein paar Modifikationen genügen, und schon wird aus dem komfortablen Performance-Cruiser eine reinrassige Regatta-Yacht.** Für kleine und große Crews, für die All-day-Wettfahrt mit Freunden und Steg-Nachbarn, für die Regatta mit internationalem Feld – oder einfach nur für Ihren ganz privaten sportlichen Ehrgeiz. Viel Spaß.

**Just a few modifications and your luxurious performance cruiser will be turned into a pure regatta yacht.** For smaller and bigger crews, for the all-day-races with friends and jetty neighbours – or simply for your very private sporty ambitions. Have fun.



## INDIVIDUALITY

### COMPETITION STYLE

**A** ERGONOMIC INSTRUMENT POD  
PORT SIDE & STARBOARD  
2 B&G H5000 multifunction displays

**B** HPM SAILS  
lighter and more stable with  
a longer life span

**C** CARBON RIG  
lighter and stiffer than aluminium,  
connected to hull with rod rigging

**D** ANTI-SLIP SURFACE  
for light weight sailing

**E** BOW SPRIT  
increases sailing performance  
with asymmetrical headsails

**F** COMPETITION RUDDER  
deeper and thinner construction

**G** COMPETITION STYLE  
COVELINE  
elegant and dynamic lines

**H** COMPETITION KEEL  
reduced weight and more stability

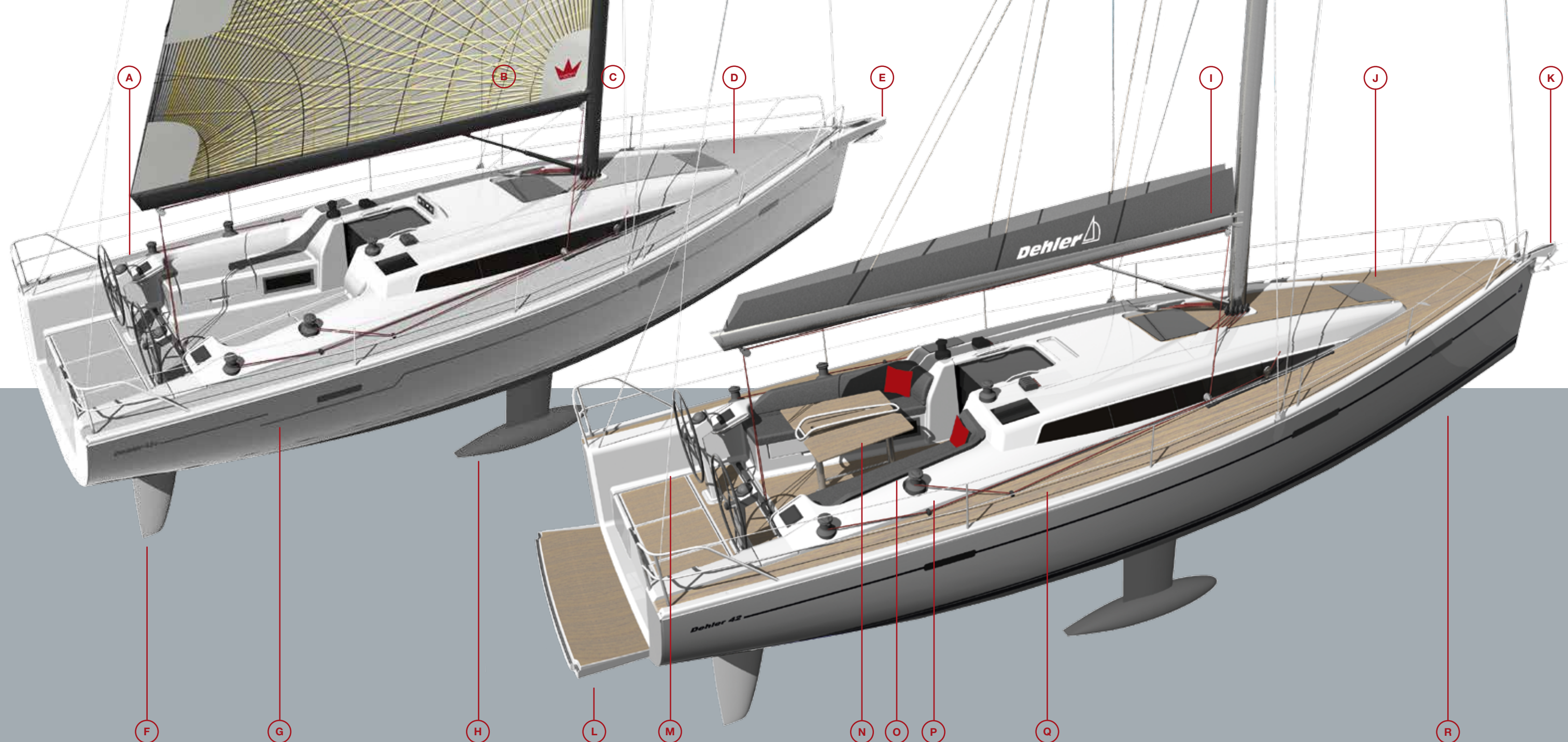

### PERFORMANCE CRUISING STYLE

**I** MAINDROP SYSTEM  
and single-line reefing

**J** TEAK ON SIDE DECKS  
natural teak and synthetic available

**K** S/S ANCHOR FITTING  
with chain up to 50 m

**L** BATHING PLATFORM  
for closed transom with integrated  
swimming ladder

**M** Y-SPOKE TWIN  
STEERING WHEEL  
for more comfortable helming

**N** COCKPIT TEAK TABLE  
with retractable LED lamp

**O** CUSTOMIZED  
UPHOLSTERY  
many colours and materials available

**P** SELF TAILING WINCHES  
for comfortable and easy sailing

**Q** GERMAN MAINSHEET  
SYSTEM  
mainsheet control from both  
helmsman positions

**R** RETRACTABLE  
BOWTHRUSTER  
for perfect handling in harbour





**Dehler** 

42

EXTERIOR

# CHARACTER THAT MEETS THE EYE

**Die Dehler 42 ist vieles:** Edles Apartment auf See, High-Tech-Sportgerät – und dank ihres Designs ein markantes Bekenntnis zum echten, unverfälschten Segeln.

**The Dehler 42 is many things:** an exquisite apartment at sea, a piece of high-tech sports equipment – and due to her design, a distinctive commitment to the unadulterated kind of sailing.







Y-spoke wheels and traveller for perfect sailing.



Wide-opening flush hatch framed with vacuum bonded teak wood.

## EXTERIOR

# DECK

Auf den ersten Blick fällt das klare, aufgeräumte Design des Decks auf. Alle Winschen, Klampen, Rollen und viele weitere clevere Details sind an der richtigen Stelle und genau so positioniert, dass beim sportlichen Segeln alles perfekt zur Hand liegt.

The distinct, clean-cut deck design catches your eye at first glance. All the winches, cleats, rollers and many smart details more are positioned just in the right places, so everything will be close at hand when sailing in a sporty way.



Teak-covered side deck with genoa tracks adjustable from the cockpit and openable windows for optimum ventilation.



Electric anchor with remote control.



The bathing platform enhances the space on deck.





The latest Dehler innovation: **recessed cockpit seats** give more safety when sailing.



Keeps the beauty of your yacht: **underdeck furler and rounded spring cleats.**



Cockpit table with **retractable LED-light.**



Smart solution – **the integrated companionway hatch.**



**Ergonomic pod** with backrest, handle and intelligent 9" multifunctional navigation display. Starboard with bow thruster control, portside with sound system.







## EXTERIOR

# HULL

**Die innovative Vakuum-Infusions-Technologie** sorgt dafür, dass der 12,42 Meter lange Rumpf 20 Prozent steifer als bei herkömmlicher Bauweise wird. Dehler geht noch einen Schritt weiter und kombiniert die Vakuum-Infusions-Technologie mit der Vollsandwich-Bauweise, bei der auch unterhalb der Wasserlinie hochwertiges Sandwichlaminat verbaut wird. Das Ergebnis: ein Quantensprung an Gewichtsersparnis. Als weiteres Detail verlängert der steile Steven die Wasserlinie und ermöglicht so eine erhöhte Rumpfgeschwindigkeit.

**Innovative vacuum-infusion technology** in the Dehler 42 ensures that the 12.42-metre-long hull, is 20 percent stiffer than conventional constructions. Dehler also goes a step further, combining vacuum-infusion technology with the full-sandwich construction, which includes the use of premium sandwich laminate below the waterline. This means you'll enjoy a huge leap in weight savings. Another highlight is the steep stem, which extends the waterline and thus lets you experience a boost in hull speed.



Sail upwind, downwind or reach maximum speed due to the **versatile hull design**.



## TECHNICAL RIG SPECIFICATIONS

	ALU RIG
Weight	280 kg / 618 lbs
Shrouds	1x19
Backstay	one-sided
Spreader	alu
Boom	alu
Boom vang	alu
Main sail Sliders	Selden
Total Sail Area	93.00 m <sup>2</sup> / 1,001 sq ft
I	16.44 m / 53'11"
J	4.63 m / 15'2"
P	16.10m / 52'10"
E	5.70 m / 18'8"

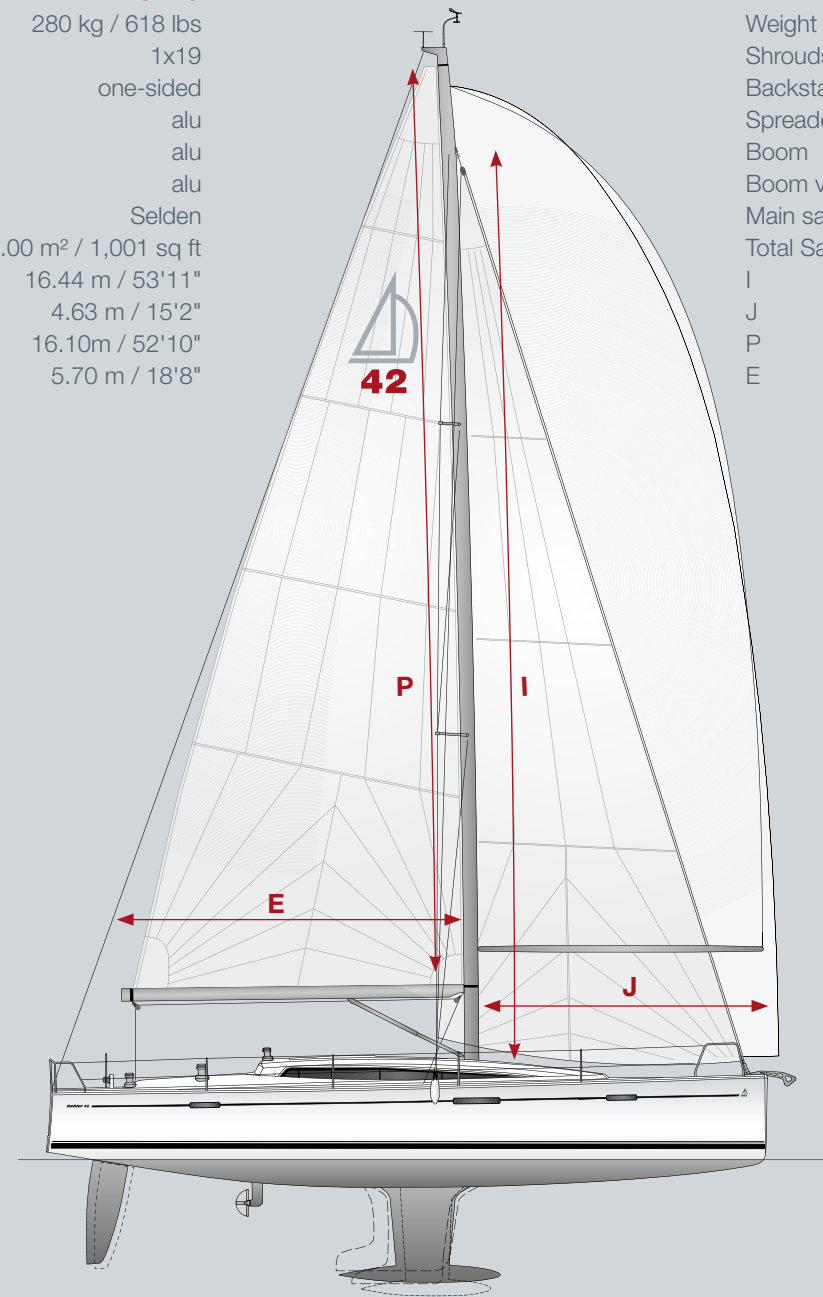

	CARBON RIG
Weight	195 kg / 430 lbs
Shrouds	rod rig
Backstay	one side hydraulic
Spreader	carbon
Boom	carbon
Boom vang	carbon
Main sail Sliders	Antal
Total Sail Area	105.50 m <sup>2</sup> / 1,135 sq ft
I	16.90 m / 55'5"
J	4.63 m / 15'2"
P	16.90 m / 55'5"
E	5.80 m / 19'0"

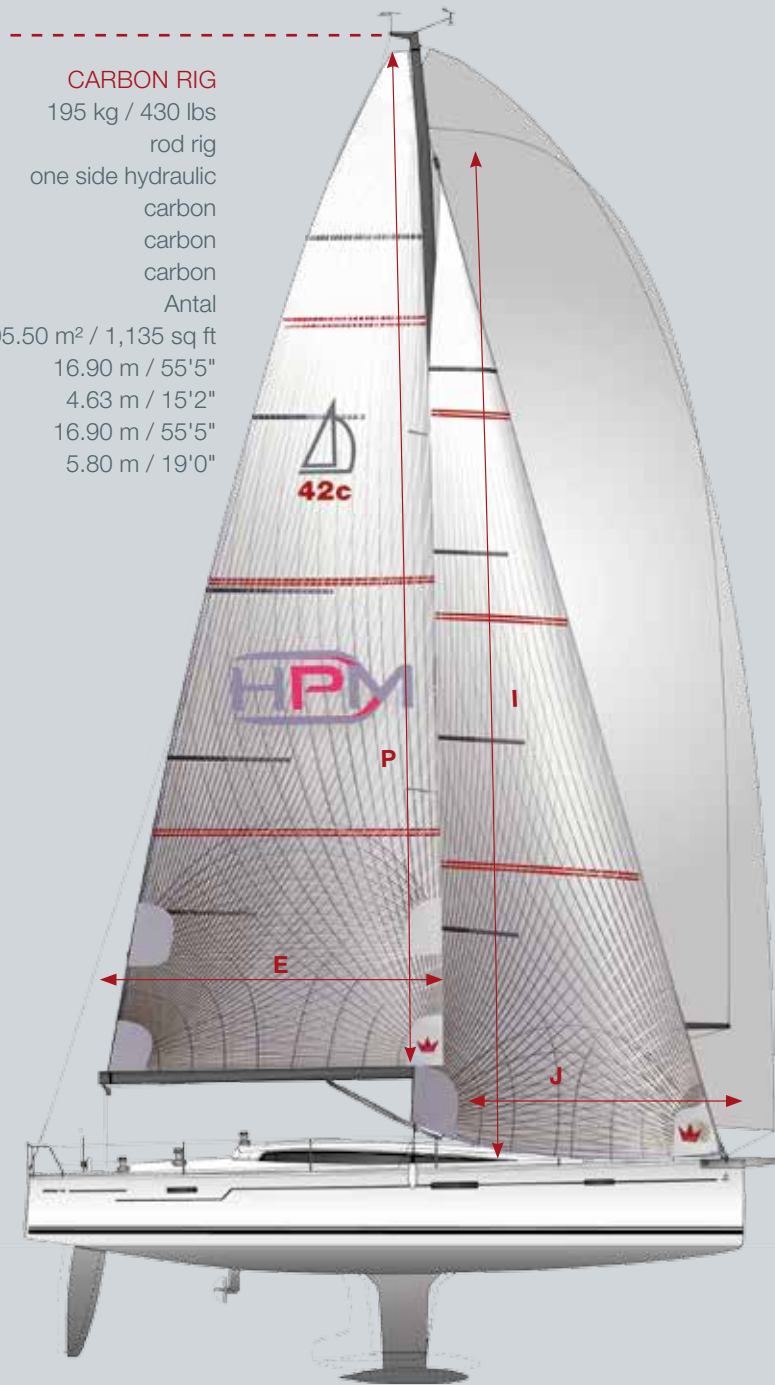

## EXTERIOR

# CARBON RIG

**Unser Rigg aus dem High-tech Werkstoff Carbon bringt entscheidende Vorteile:** Der Mast ist länger, leichter und steifer als der Standard-Alu-Mast, bietet eine größere Segelfläche – und damit ein Mehr an Segelleistung bei leichtem Wind und bei Seegang. Zudem sind die Carbonteile witterungsbeständiger und langlebiger als Aluminium.

**Making our rig of the high-tech material carbon provides decisive advantages:** the mast is longer, lighter and stiffer than the standard alu mast. It enlarges the sail area which increases the seailing performance in rough seas and light winds. In addition, the carbon parts are more weather-resistant than aluminium.

## BOOST YOUR SAIL PERFORMANCE BY 20 S/NM

When equipped with HPM sails and carbon rig, competition rudder and deep keel, your Dehler 42 sails significantly faster:

ALU RIG		CARBON RIG	
at 16 kn true wind		at 16 kn true wind	
39°	7.31 kn	37.7°	7.31 kn
60°	8.33 kn	60°	8.35 kn
90°	8.77 kn	90°	9.97 kn
120°	8.18 kn	120°	8.31 kn
135°	7.85 kn	135°	7.98 kn

As a result the yacht is approx. **20 s/nm faster**, achieving an ORC value of **GPH 580 s/nm**.

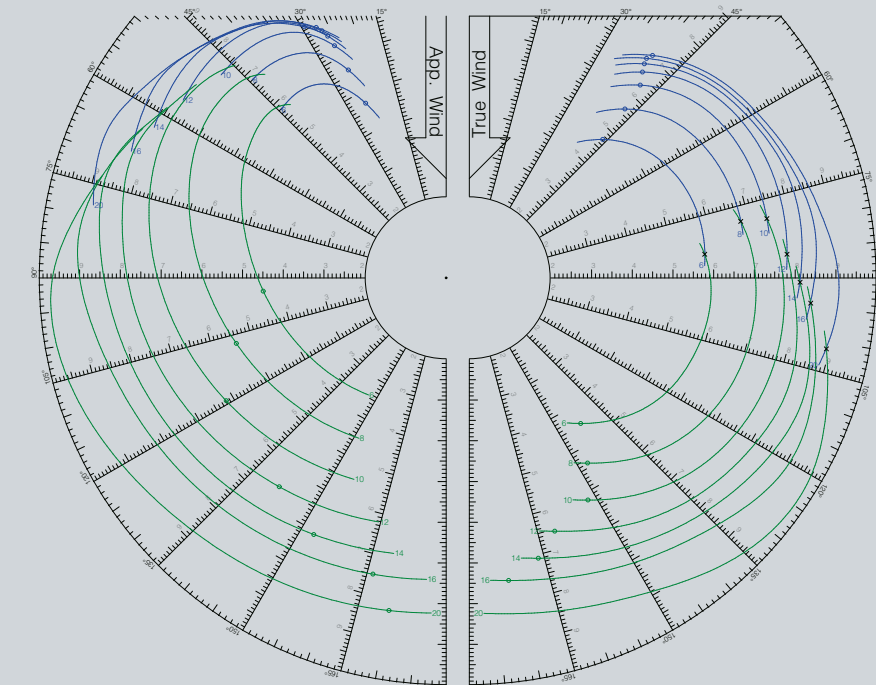





**NEW!**

# DEHLER CODE ZERO

Der neue Dehler **CODE ZERO** besitzt die perfekte Segelgröße zwischen Genua und Gennaker und hat den größten Windeinsatzbereich seiner Klasse. Das heißt: Vom Am-Wind-Kurs bis zum tiefen Raumkurs bringt das CODE ZERO Ihre Dehler auf Geschwindigkeit.

Dabei ist es ein voll einhandaugliches Segel. Es wird aus dem speziell entwickelten Sailbag vom Deck gesetzt. Mit zwei Klicks wird es am Ankerbeschlag und Gennakerfall befestigt und kann eingerollt als zweites Vorstag im Hafen gesetzt bleiben. Gefahren wird das Dehler CODE ZERO mit den Gennakerschoten über eine beliebige Winsch im Cockpit.

The new Dehler **CODE ZERO** is the perfect intermediate size between genoa and gennaker, offering the largest wind range in its class. The CODE ZERO speeds up your Dehler, no matter if you are sailing a close reach or broad reach course. Fully optimised for single-handed sailing, it is set out of the specially designed sailbag at deck level. Attaching it to the anchor arm and gennaker halyard takes two simple clicks. The rolled-up sail can remain set as second forestay in the marina. It is operated with the gennaker sheets using any winch in the cockpit.

## DEHLER CODE ZERO

- | 72 m<sup>2</sup> sail area, for wind speeds starting at 5 kn
- | Made of CZ laminate with trioptimal cut – a very lightweight pale grey material containing Twaron high-performance fibres and black Technora X – Ply
- | Quickly fixed with just two clicks and rolled out
- | High-grade furling system and special torsion cable included
- | Specially developed weatherproof sailbag



UV-protected

integrated torsion cable and endless furling system

wind range starting at 5 kn

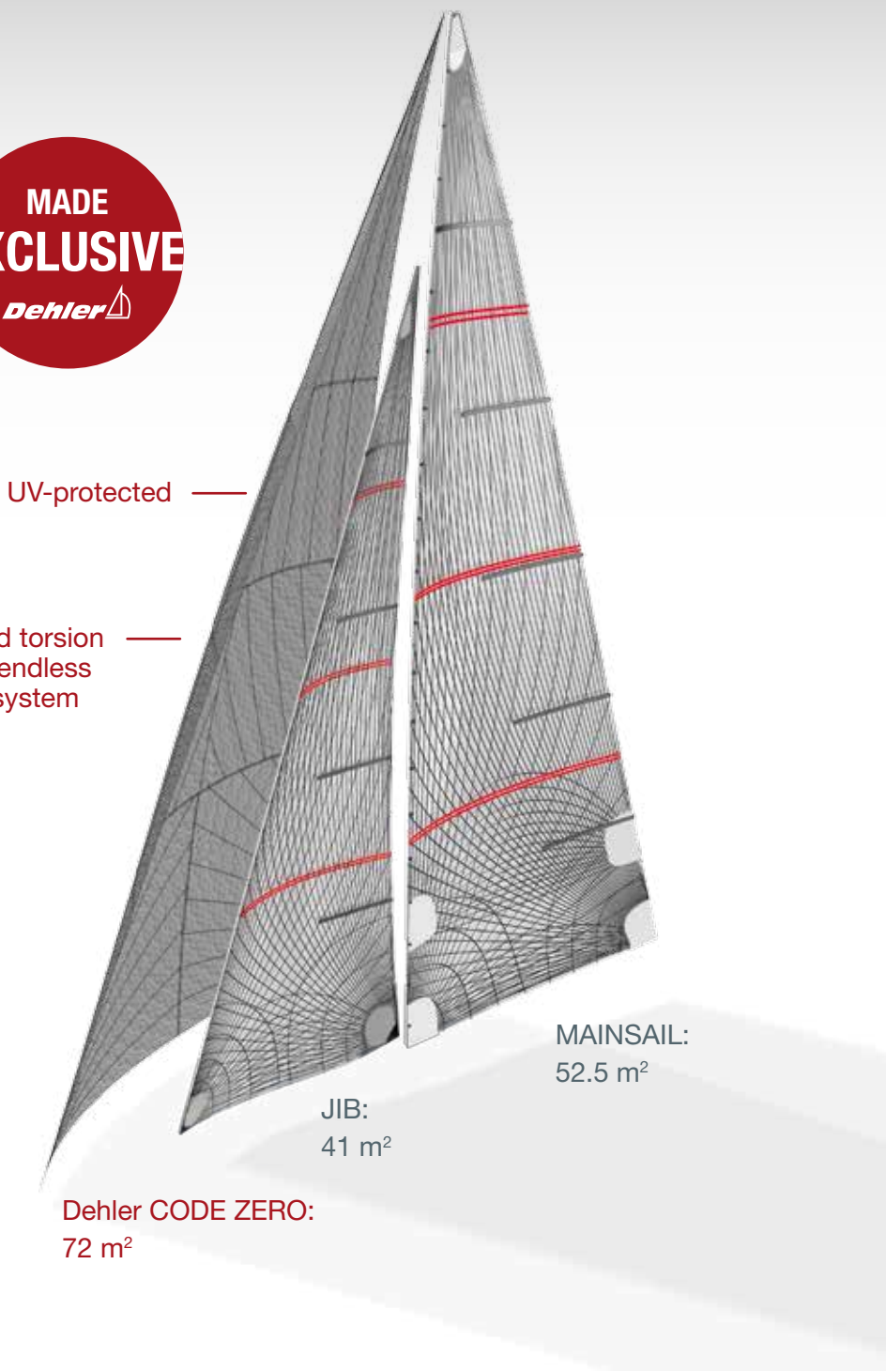
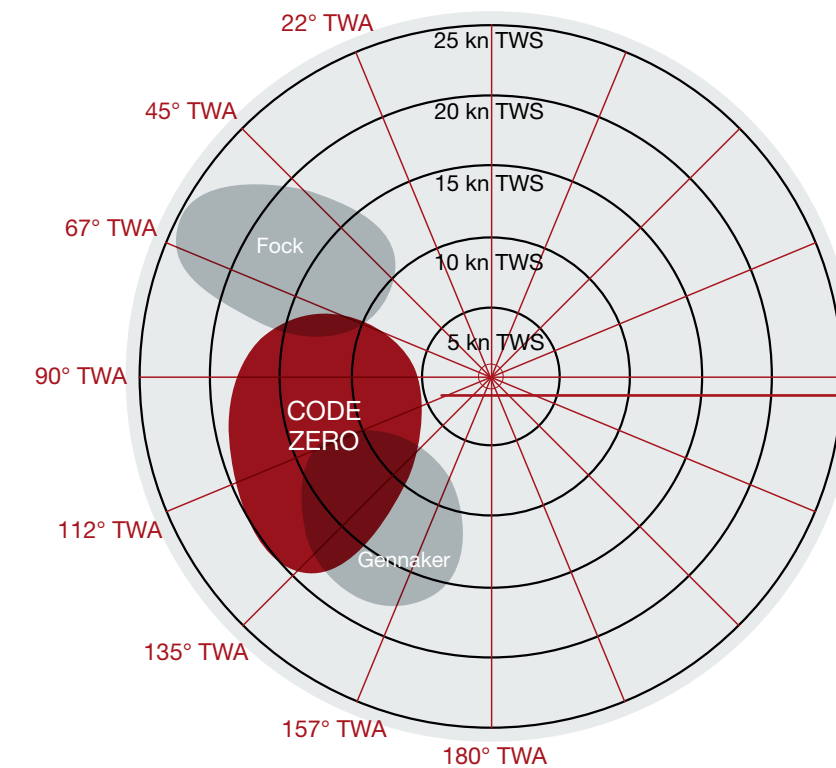

MAINSAIL:  
52.5 m<sup>2</sup>

JIB:  
41 m<sup>2</sup>

Dehler **CODE ZERO**:  
72 m<sup>2</sup>



## EXTERIOR

# TECHNICAL SPECIFICATIONS

Mit unseren vielfältigen Ausstattungsoptionen können Sie Ihre Dehler auf Ihr Segelrevier und Ihre Art zu segeln abstimmen. Wählen Sie aus vier Kielarten – von der Flachwasser- bis zur Performance-Version mit extrem tiefem Schwerpunkt. Wünschen Sie es noch sportlicher, nehmen Sie das Carbon- anstelle des Aluminium-Riggs. Für die optimale Geschwindigkeit bei tieferen Kursen bietet Ihnen die Dehler 42 die Möglichkeit, gleich drei verschiedene Segel einzusetzen.

Thanks to our diverse range of configuration options, you can perfectly adapt your Dehler to your yachting waters and manner of sailing. Choose from four keel types: from shallow water to a performance version with an extremely low centre of gravity. If you want it even sportier, opt for the carbon rig instead of aluminium. When it comes to achieving optimal speeds with downwind courses, your Dehler 42 lets you select from three different sails.

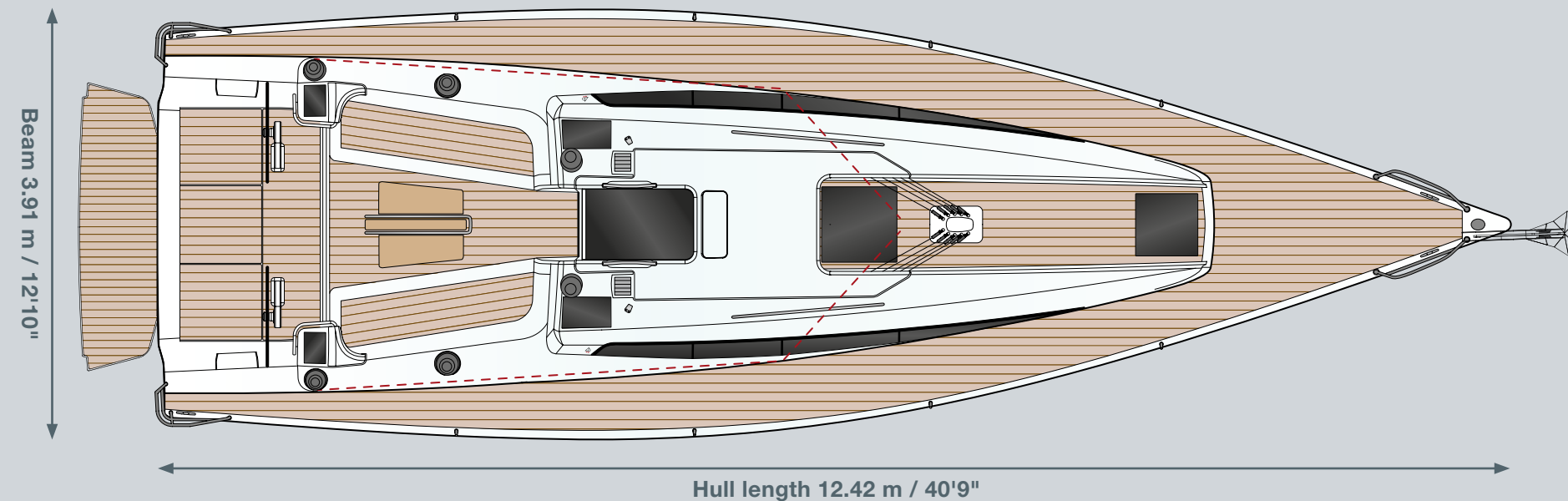

Hull length 12.42 m / 40'9"

## TECHNICAL SPECIFICATIONS

### HULL

LOA	12.84 m / 42'2"
Hull length	12.42 m / 40'9"
LWL	11.50 m / 37'9"
Beam	3.91 m / 12'10"

### DRAUGHT

Standard	2.15 m / 7'1"
L-keel medium	2.16 m / 7'1"
Competition	2.38 m / 7'10"
Shallow	1.98 m / 6'6"

### DISPLACEMENT

Standard	9.10 t / 20,062 lbs
L-keel medium	9.20 t / 20,282 lbs
Competition	8.70 t / 19,180 lbs
Shallow keel	9.50 t / 20,943 lbs

### BALLAST

Standard	3.00 t / 6,614 lbs
L-keel medium	3.00 t / 6,614 lbs
Competition	2.60 t / 5,732 lbs
Shallow keel	3.25 t / 7,165 lbs

### ENGINE

Diesel	29 PS / hp
--------	------------

### TANKS

Fresh Water	295 l / 77.93 gal
Fuel Tank	160 l / 42.27 gal

### HULL DESIGN

judel/vrolijk & co.

### INTERIOR DESIGN

Dehler

### CE CERTIFICATE

A - 10

### RIG

Mast length above WL	
Standard	19.50 m / 63'12"
Competition	20.25 m / 66'4"

### Standard

I	16.44 m / 53'11"
J	4.63 m / 15'2"
P	16.10 m / 52'10"
E	5.70 m / 18'8"

### Competition

I	16.90 m / 55'5"
J	4.63 m / 15'2"
P	16.90 m / 55'5"
E	5.80 m / 19'0"

### MAINSAIL

Standard	52.50 m <sup>2</sup> / 565 sq ft
Competition	57.50 m <sup>2</sup> / 618 sq ft

### JIB

Standard (105%)	41.00 m <sup>2</sup> / 441 sq ft
Competition (105%)	43.00 m <sup>2</sup> / 462 sq ft

### TOTAL SAIL AREA

Standard	93.00 m <sup>2</sup> / 1,001 sq ft
Competition	105.50 m <sup>2</sup> / 1,135 sq ft

### SPINNAKER

Standard	130.00 m <sup>2</sup> / 1,399 sq ft
Competition	145.00 m <sup>2</sup> / 1,560 sq ft

### GENNAKER

Standard	120.00 m <sup>2</sup> / 1,291 sq ft
Competition	145.00 m <sup>2</sup> / 1,560 sq ft

### CODE ZERO

Standard	72.00 m <sup>2</sup> / 775 sq ft
Competition	78.90 m <sup>2</sup> / 849 sq ft







EXTERIOR

# MATERIALS & COLOURS

**Die Farbe des Rumpfes, der Stil des Teak-Decks:** Erst mit der Gestaltung der Oberflächen verleihen Sie dem Exterieur seinen letzten Schliff.

**The colour of the hull, the style of the teak deck:** it is your personal design that applies the finishing touches to the exterior.

## EXTERIOR | GELCOAT HULL, WATERLINE & COVELINE

## EXTERIOR | PAINTED HULL, WATERLINE & COVELINE

The hull, waterline & coveline can be painted in almost every colour (metallic/non metallic) according to the Alexseal Yacht Coatings Selection.

STANDARD

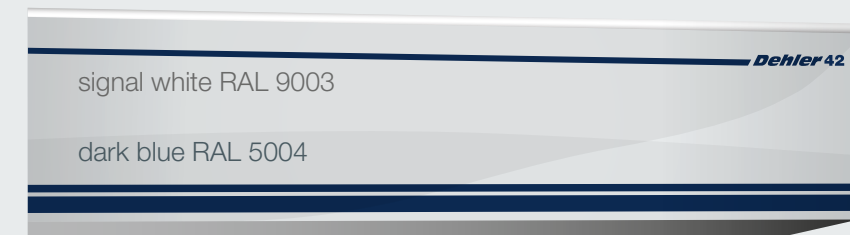

OPTIONS

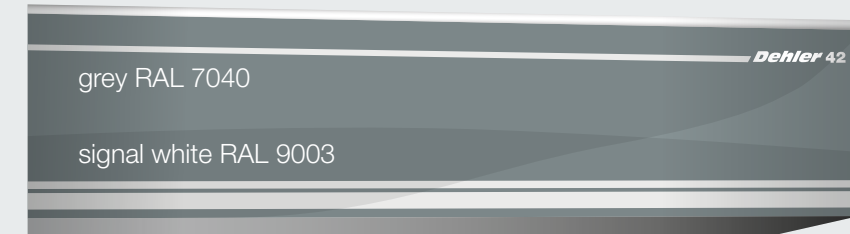

OPTIONS

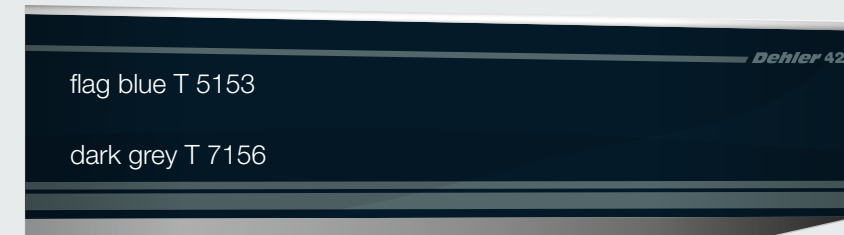
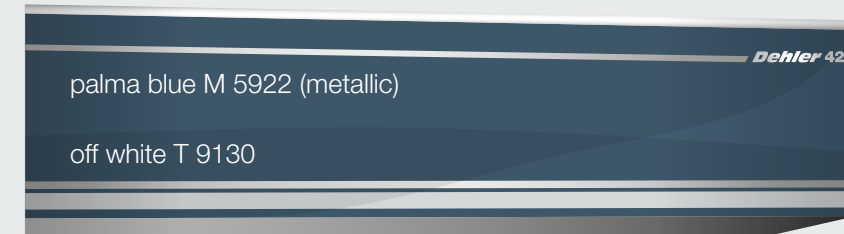



## EXTERIOR | COVERS & UPHOLSTERY

### Maindrop, Sprayhood, Steering Wheel Cover, Cockpit Table Cover

#### OPTIONS

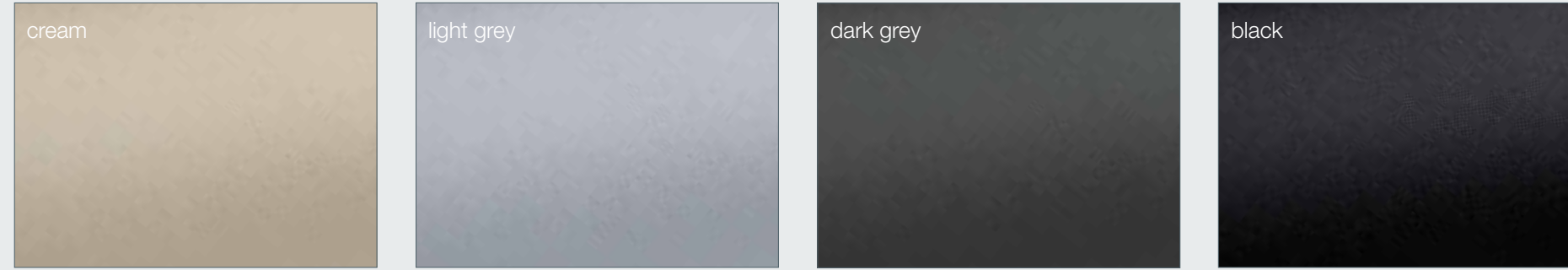

### Cockpit Cushions

#### OPTIONS

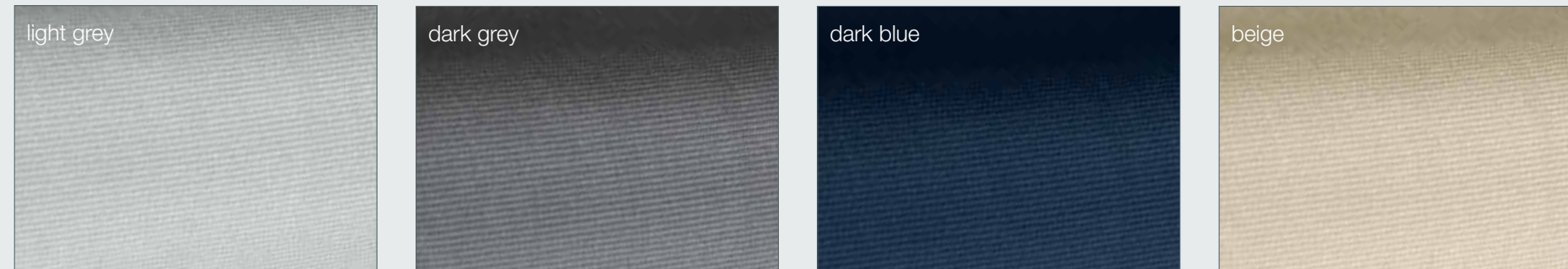

## EXTERIOR | NATURAL TEAK & SYNTHETIC TEAK

### NATURAL TEAK OPTION



### SYNTHETIC TEAK OPTIONS

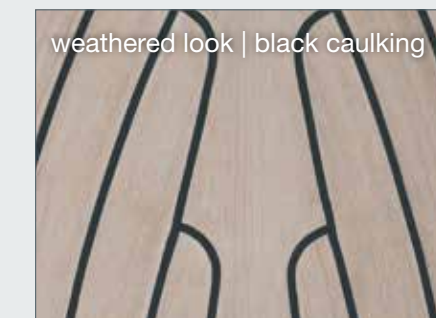
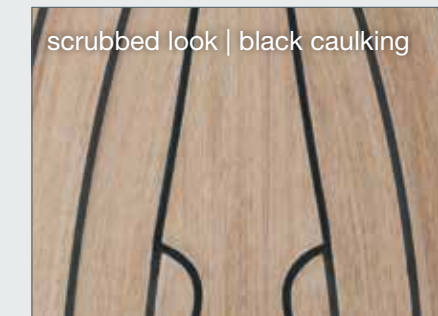
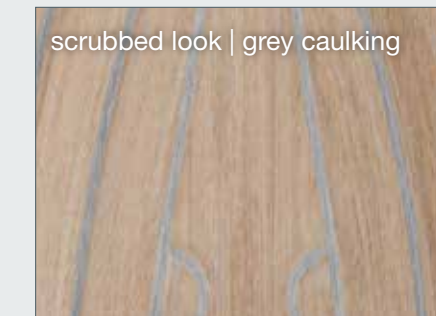
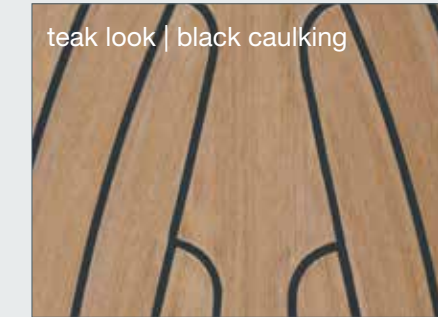
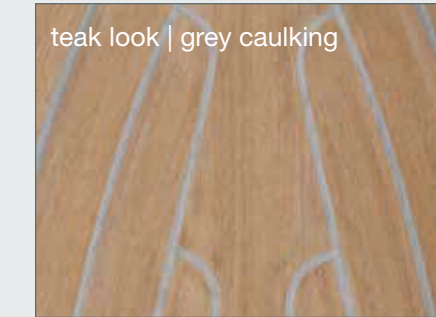







**Dehler**   
**42**

INTERIOR

# DESIGNED TO MAKE YOU FEEL AT HOME

**Machen Sie es sich bequem.** Gestalten Sie den harmonischen Innenraum mit seinen elegant fließenden Formen nach Ihren Wünschen.

**Make yourself comfortable.** Style the harmonious interior with its elegantly flowing shapes to suit your preferences.







Shift the chart table to increase seating space or to create another berth.



Cleverly hidden: the saloon table features a pull-out wine bar.

## INTERIOR

# SALOON & PANTRY

Der zentrale Bereich im Salon bietet zahlreiche bemerkenswerte Lösungen zur optimalen Raumnutzung. So lassen sich zum Beispiel die Salonschränke mit ihren markanten Rundungen praktischerweise nach oben öffnen.

The central area of the saloon provides many remarkable ways of using space efficiently. For example, the saloon cabinets with their distinctive curves open upwards in a practical fashion.



A feast for the eye: gently rounded shapes and superb mahogany woodwork.





Large two-part sink. Put on both covers to use it as a worktop.



Another smart detail: wooden stove cover serving as cutting board.

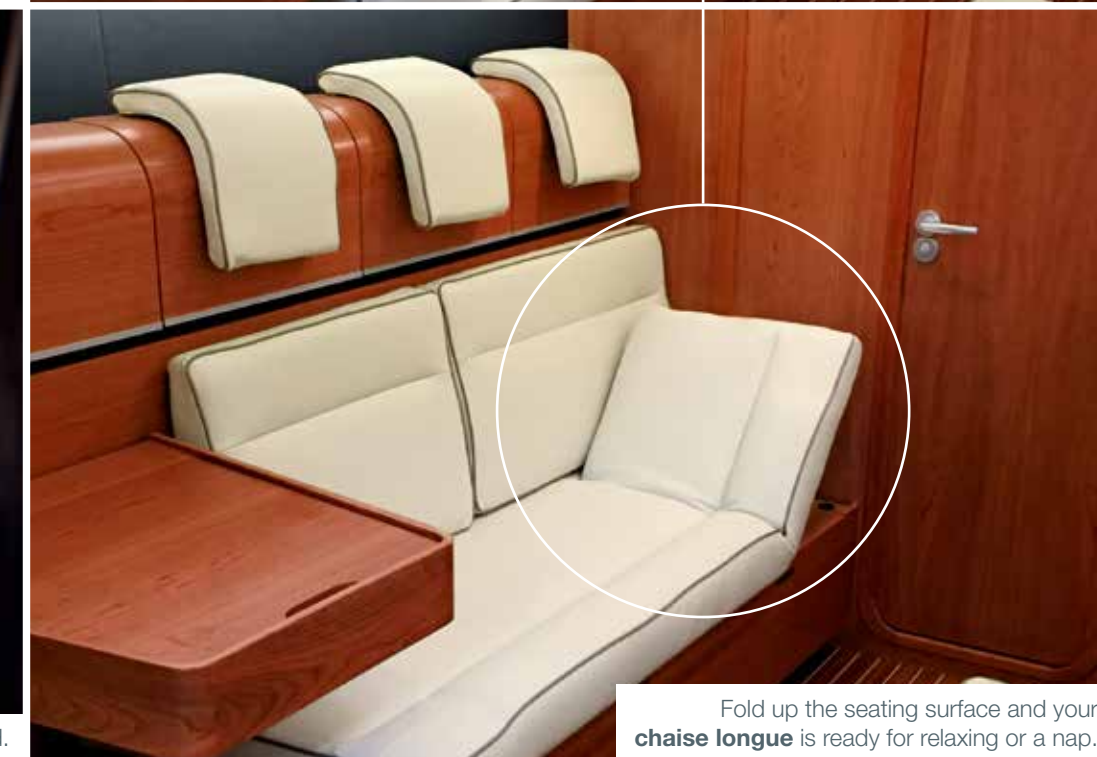

Fold up the seating surface and your chaise longue is ready for relaxing or a nap.





Spacious galley where everything is in the right place.



Seating area with foldable saloon table and pull-out wine bar.







Additional spacious guest cabin on portside.

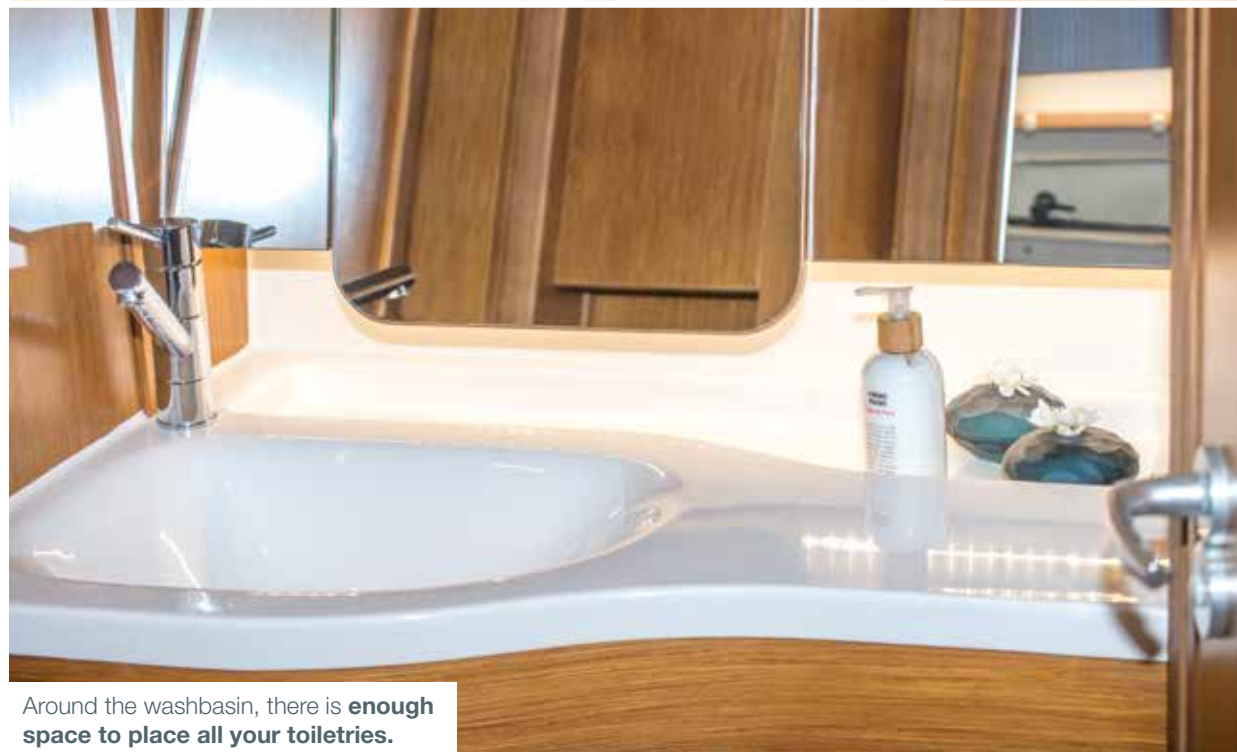

Around the washbasin, there is enough space to place all your toiletries.

## INTERIOR

# MASTER & GUEST CABIN

In der **Standard-Version** verfügt die Dehler 42 über eine Eignerkabine, eine geräumige Achterkabine steuerbord und einen großen, begehbaren Stauraum backbord, den Sie als Segellast oder für sonstige Bordausrüstung nutzen können. An dessen Stelle können Sie auch eine **zweite Achterkabine wählen**.

The **standard Dehler 42** has a master cabin, a spacious aft cabin starboard and a large storage room portside, which can be used for board equipment or as a sail locker. However, you can also **choose to have a second aft cabin**.



The **Smart Light System (SLS)** dims each light in the master cabin to the desired brightness.



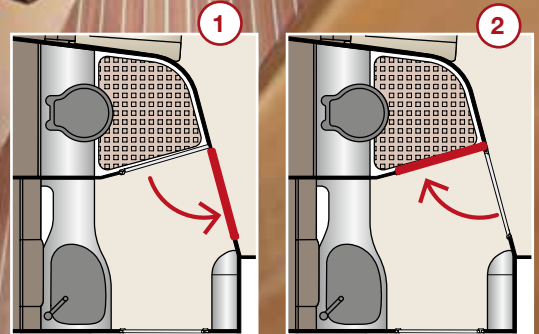
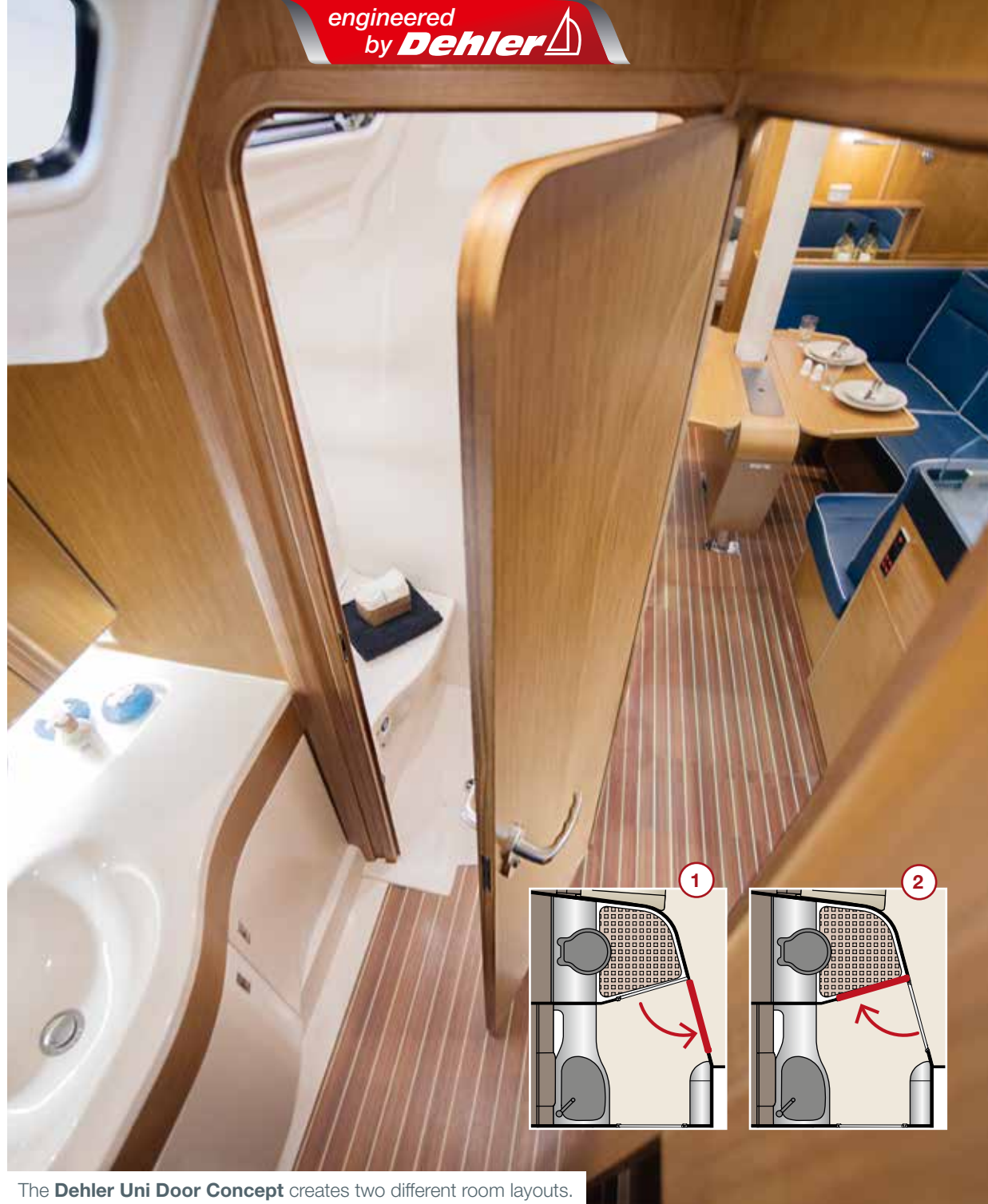

The **Dehler Uni Door Concept** creates two different room layouts.

INTERIOR

# CABIN LAYOUTS

**Darauf sind wir stolz:** Das Dehler Uni Door Concept, das Ihnen stets die Wahl zwischen zwei Raum-Layouts lässt. Der Clou dabei ist eine Tür für zwei Rahmen. Schwingt die Tür zur einen Seite, entsteht ein geräumiges Badezimmer, das vom Salon getrennt ist. Schwingt sie zur anderen, verschließt sie stattdessen den Raum mit Dusche und WC. Gleichzeitig gibt sie den Durchgang vom Bad zum Salon frei, was ein besonders großzügiges Raumgefühl schafft.

**We are proud of** our Dehler Uni Door Concept which always gives you a choice between two room layouts. Its key feature is having one door for two frames. The door swings open one way onto a roomy bathroom that is separate from the saloon. When the door swings the other way, it closes the shower and toilet room instead. The hallway from the bathroom to the saloon is free at the same time, making the room feel very spacious.

DEHLER UNI DOOR CONCEPT

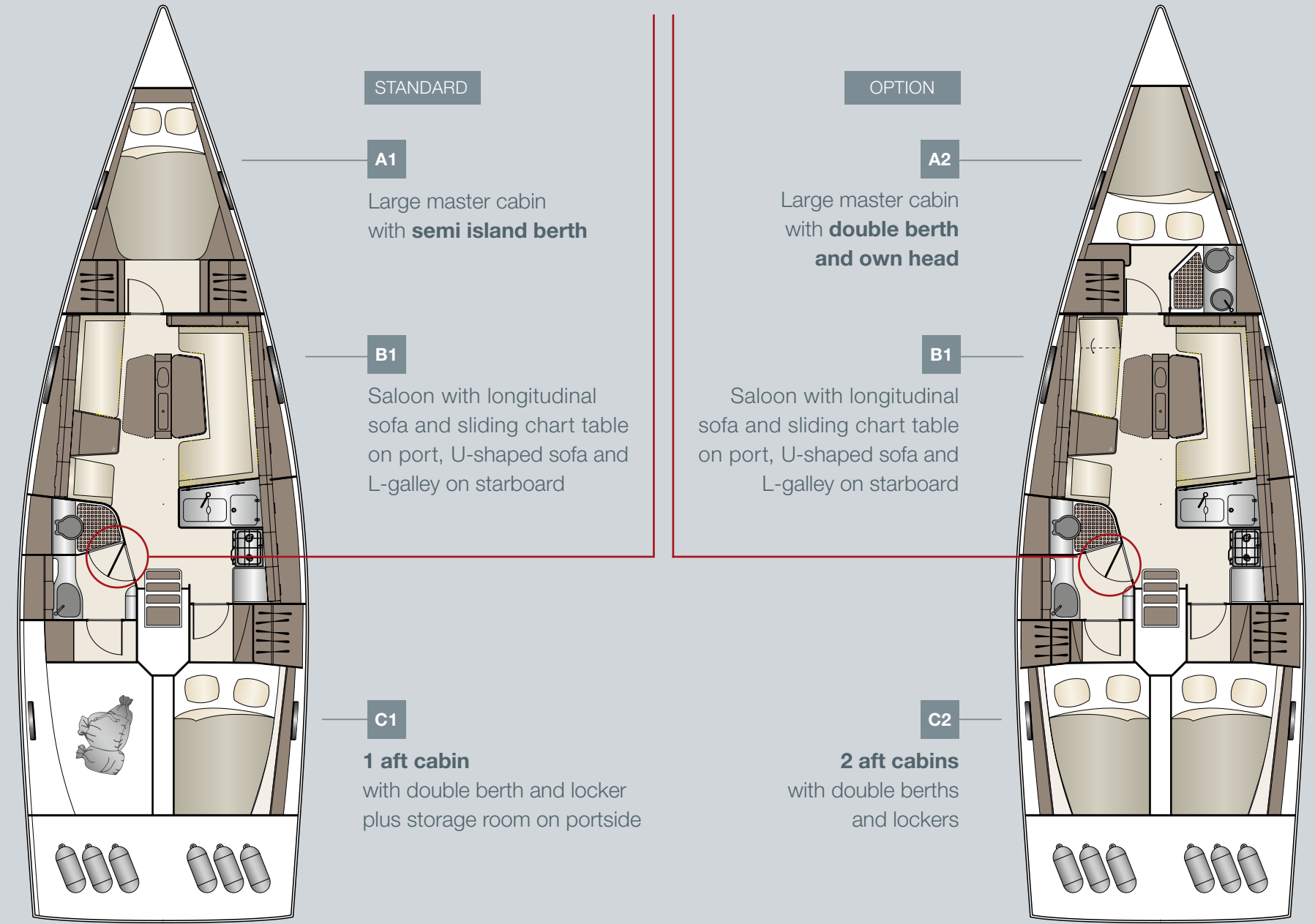



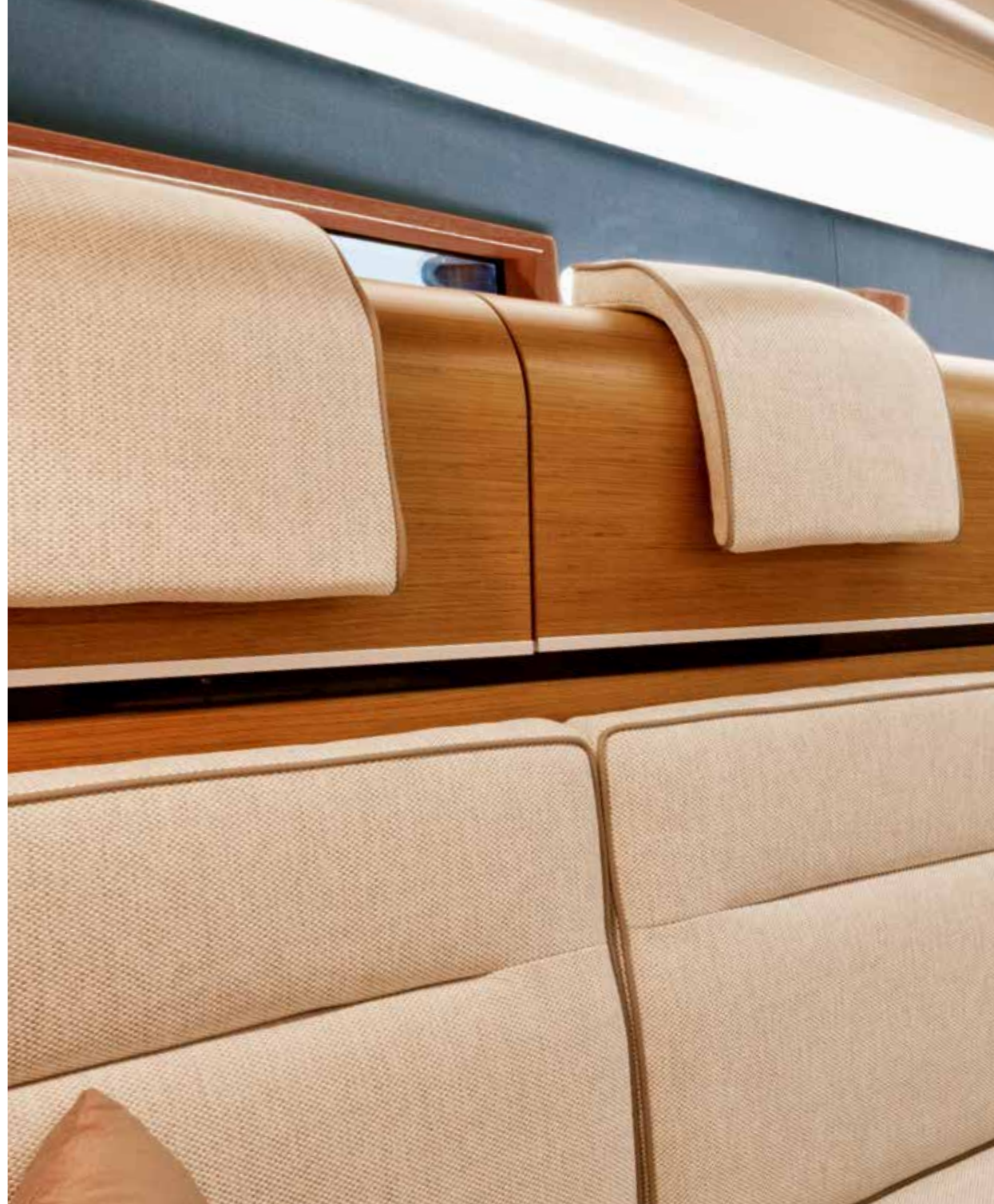

## INTERIOR

# MATERIALS & COLOURS

**Selbstverständlich bieten wir Ihnen auch Gestaltungs-Varianten** für die Fußböden, das Holz der Möbel, die Arbeitsplatte in der Pantry und für die Polster. Gestalten Sie die Dehler 42 nach Ihrem Geschmack.

**It goes without saying that we also offer you a variety of designs** for the floorings, furniture wood, worktop in the galley and for the upholstery. Design the Dehler 42 to your own preferences.

## INTERIOR | UPHOLSTERY BALTIC

**Mix and match as you wish.**

All upholstery can be matched with the following piping colours: gold, silver, red, blue and black.

### STANDARD

cream / gold piping



blue / silver piping



dark grey / red piping



red / black piping



chocolate / blue piping





## INTERIOR | UPHOLSTERY ATLANTIC

Mix and match as you wish.

All upholstery can be matched with the following piping colours: gold, silver, red, blue and black.

### OPTIONS



## INTERIOR | UPHOLSTERY PACIFIC

Mix and match as you wish.

All upholstery can be matched with the following piping colours: gold, silver, red, blue and black.

### OPTIONS

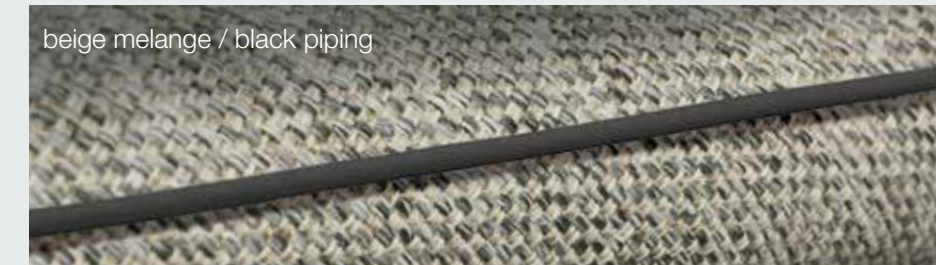
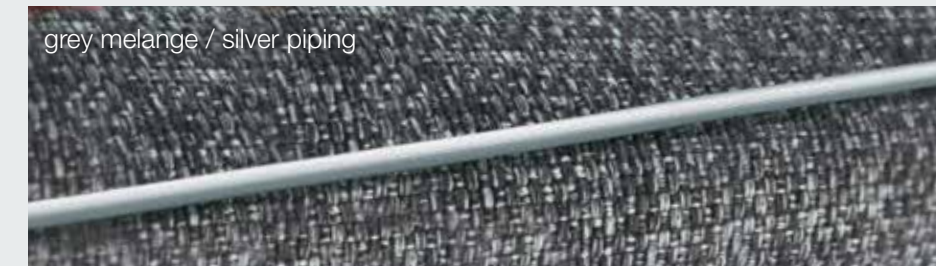



# INTERIOR | UPHOLSTERY ADRIATIC LEATHER

Mix and match as you wish.

All upholstery can be matched with the following piping colours: gold, silver, red, blue and black.

## OPTIONS



# INTERIOR | SURFACES

## Worktop Galley

### STANDARD

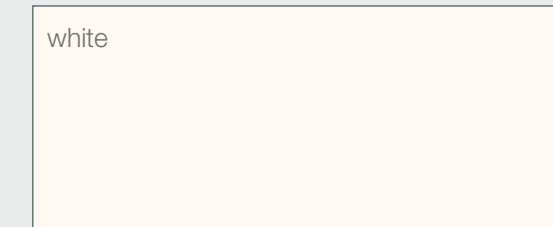

### OPTIONS



## Furniture Wood

### STANDARD

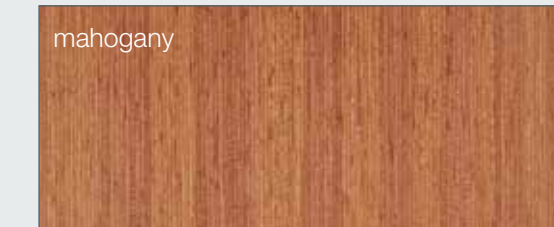

### OPTIONS



## Floorboards

### STANDARD

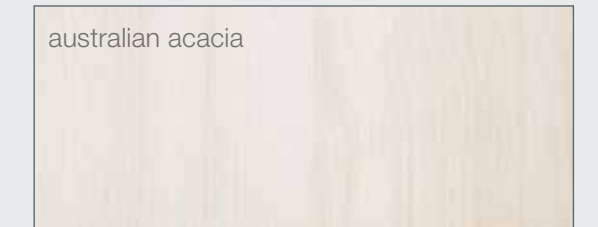

### OPTIONS

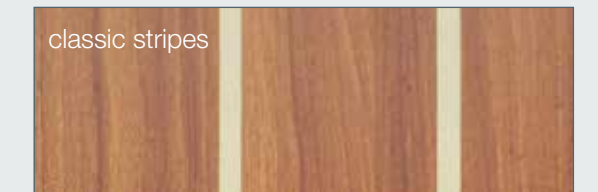







## TECHNOLOGY

# DEEPER INSIDE

Die Dehler 42 ist durchdacht und perfektioniert bis ins letzte Detail. Es wird mit der führenden 3D-Software CATIA entworfen, die auch im Flugzeugbau zum Einsatz kommt. Bestens geschulte Ingenieure gehen in einer virtuellen Yacht ans Werk: Sie teilen Räume intelligent auf, verleihen den Einbauten ausgefallene Formen, erfinden neue Technik – und verwandeln damit die Gesetze der Physik in ein herausragendes Segel-Erlebnis.

The Dehler 42 is well thought-out and perfected down to the last detail. It is designed with the leading 3D software CATIA, which is also used for aircraft development. Working in a virtual yacht, the most qualified engineers divide spaces in a smart way, create extraordinary furniture shapes, invent new techniques – and doing so, they turn the laws of physics into an unrivalled sailing experience.

## 3D CONSTRUCTION

### THREE-DIMENSIONAL THINKING CREATES SPACE

#### DEHLER UNI DOOR CONCEPT

The Dehler Uni Door Concept allows the use of two cabins at the same time. The door is hinged in a position that will either separate the head from the bathroom or close to the adjacent cabin to extend the space of the bath. Smart perfection!

#### FULL SANDWICH HULL

The sandwich construction allows to make the hull thicker and lighter at the same time. In addition, it insulates against severe cold or heat.

- Sealing: saltwater-resistant gelcoat
- Core: high tech foam
- Outer skin: glass fibre laminated with vinylester resin

#### ENGINE

The engine room is placed in a space saving manner beneath the companionway.

- All points used for regular maintenance are easily accessible
- Sound-insulated housing
- Comes with folding prop as standard

#### DIESEL TANK (160 l)

- Perfect capacity for long-range cruising
- Optimum weight distribution due to central installation in transom
- Low center of gravity increasing the righting moment

#### HULL WINDOWS

- More natural light inside the boat
- Extra large saloon window

#### FRESH WATER TANK (295 l)

- Installed beneath the bow cabin
- More storage space in saloon
- Improves weight distribution of the entire yacht

#### BOW SPRIT

- Increases sailing performance with asymmetrical headsails
- Allows for increased gennaker surfaces thus hence increasing downwind performance
- Easier gybing due to increased space between sail and forestay
- Allows for headsails such as CODE ZERO

#### UNDER DECK FURLER

- Clew can be attached directly above deck as with common non furling head stays
- maximum use of sail area
- Easy handling with small crew

#### BOW THRUSTER

- Better manoeuvrability in narrow harbours
- No loss in speed due to retractability of thruster into the hull

#### CHAINPLATE

- High rigidity and stability: loads are directly distributed into hull structure
- No loss of tension or hull torsion hence increased performance
- Increased rig performance: wider spreaders result in a stiffer rig

#### KEEL STEPPED MAST

- Leads forces directly into the carbon cage
- Increases rigidity, minimizes deck pressure
- Weighs less than a deck stepped mast
- Easier to trim, more seaworthy and secure

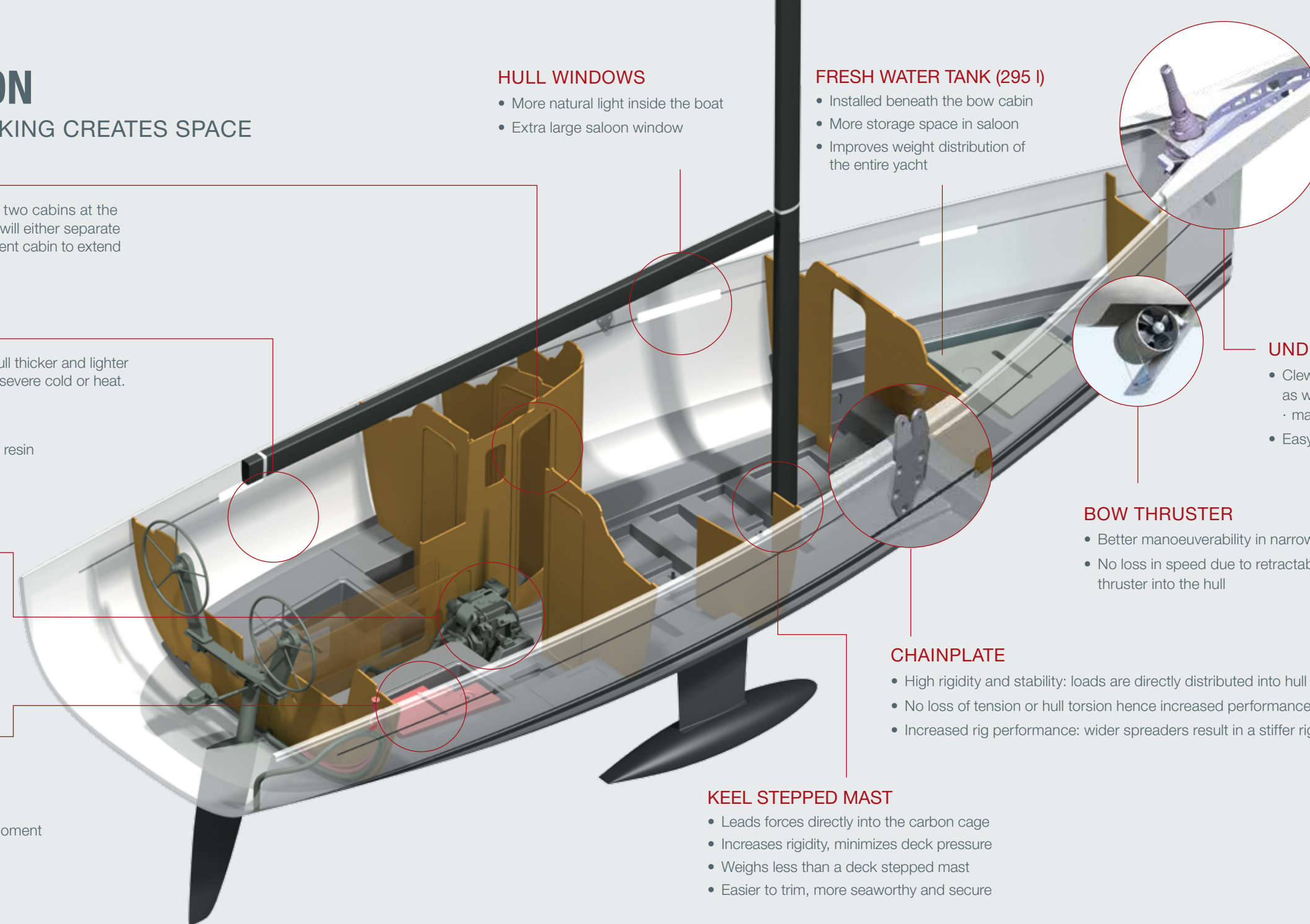



## VACUUM INFUSION TECHNOLOGY

### LIGHTER, STIFFER, STRONGER.

Dehler uses a state-of-the-art process to join the hull layers. After all air has been drawn off, resin is sucked into the laminate by vacuum pressure via carefully placed tubing. This technique delivers just the right amount of resin to every inch – without voids, dry or over-wetted spots. Vacuum infusion will be applied on special request.

- Stronger hull – 20% more rigidity
- Significant weight savings
- High durability due to high-quality vinylester resins



## KEEL TYPES

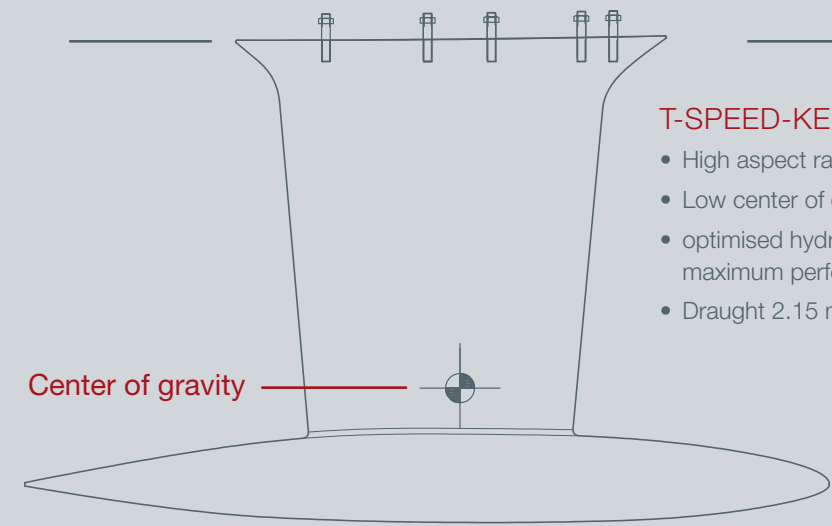

### T-SPEED-KEEL

- High aspect ratio keel
- Low center of gravity
- optimised hydrodynamics for maximum performance
- Draught 2.15 m, Weight 3,000 kg

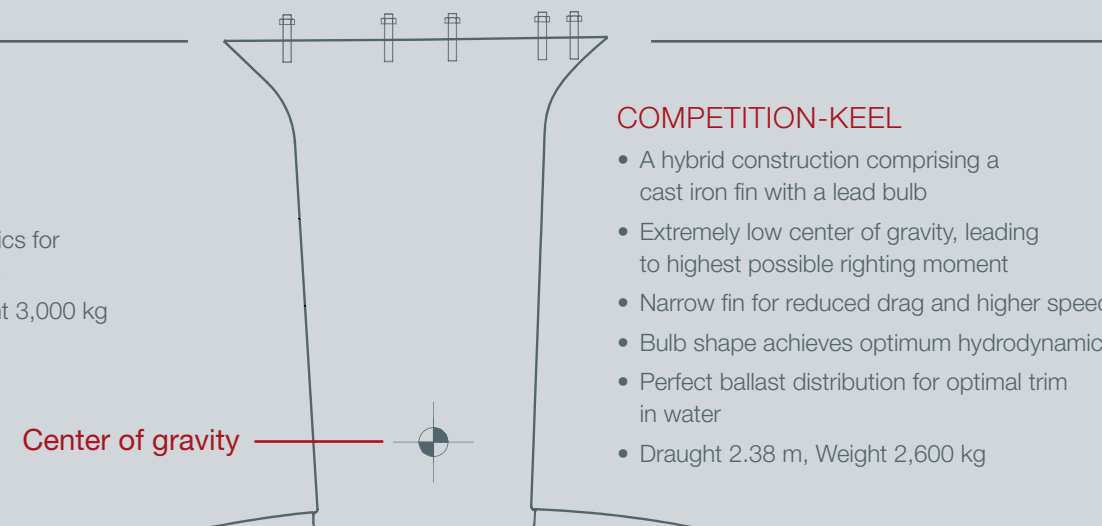

### COMPETITION-KEEL

- A hybrid construction comprising a cast iron fin with a lead bulb
- Extremely low center of gravity, leading to highest possible righting moment
- Narrow fin for reduced drag and higher speed
- Bulb shape achieves optimum hydrodynamics
- Perfect ballast distribution for optimal trim in water
- Draught 2.38 m, Weight 2,600 kg

## DEHLER CARBON CAGE

A rigid floor structure is the secret in strong and well performing hulls. Being the backbone of the yacht, it directly affects the sailing performance. That is why the Dehler Carbon Cage comes as standard with the Dehler 42.

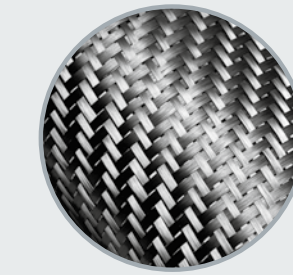

CARBON REINFORCEMENT

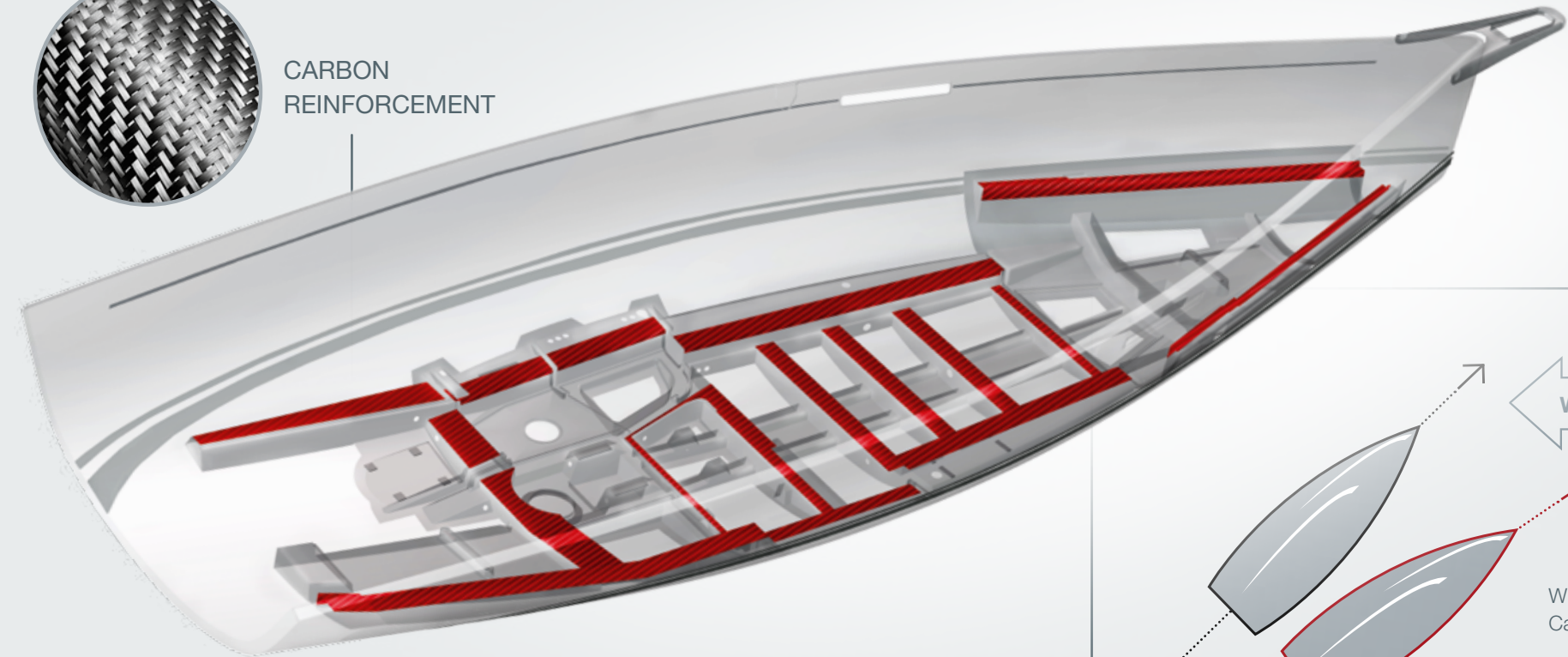

### HOW IT WORKS

The floor structure is reinforced with carbon fibre at thoughtfully selected points.

### LESS TORSION

The hull's torsion is minimised under high rig loads and in high seas, enabling it to better withstand the forces of water and wind.

### A NEW LEVEL OF STABILITY

The rigidity of the mast base is increased by 50%; the inner grid is 25% stronger.

### HIGHER LONGEVITY

A hull less stressed lasts longer and extends the life span of your yacht.

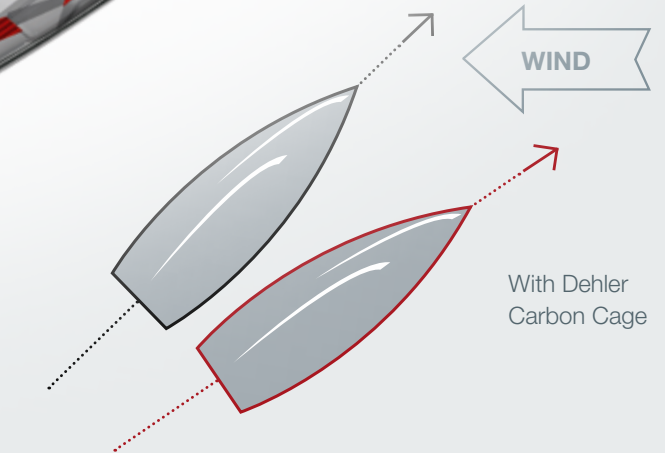

### CLOSER TO THE WIND

The Dehler Carbon Cage benefits not only ambitious sailors, it also increases the general sailing fun onboard.



**Dehler**   
**42**

INDIVIDUALITY

**AS YOU  
 LIKE IT**

Mit den folgenden Ausstattungsoptionen können Sie genau definieren, wie komfortabel bzw. wie sportlich Ihre Dehler 42 sein soll. Um Ihnen die Wahl ein bisschen zu erleichtern, bieten wir Ihnen einige Extras in besonders attraktiven Paketen an.

The following furnishing options allow you to define precisely how comfortable or sporty your Dehler 42 should be. To make your choice a little easier, we offer some extras, conveniently bundled in packages.

PACKAGES

**COMPETITION –  
 PERFORMANCE UPGRADE**



RACE PLUS  
**6**  
 WINCHES



The Package includes

- | Coveline - Competition
- | Rudder - Competition
- | 2 GRP steering wheels, Y-spoke (black or white)
- | 4 LEWMAR 45 Race Plus manual winches
- | 2 LEWMAR 50 Race Plus manual winches

PACKAGES

**NAVIGATION –  
 COMPETITION UPGRADE**



The Package includes

- | 2 B&G H5000 multifunction displays, 1 per helm station, incl. transducer
- | B&G Autopilot with H5000 control unit and Precision 9 compass
- | B&G CPU Hydra computer (only with B&G H5000 instrument)

PACKAGES

**ENTERTAINMENT –  
 PREMIUM UPGRADE**



The Package includes

- | FUSION MS-AV750 Multimedia radio with bluetooth and CD/DVD player – for saloon and cockpit

TV Package

- | LED TV Flatscreen in saloon
- | TV lifting system
- | DVB-T2 antenna for TV





Dehler Maindrop system with lazy bags, available in different colours.



Electrical anchor windlass with remote control.



Elvstrøm gennaker trioptimal.



Cockpit table with retractable light.



DELTA anchor incl. anchor fitting, 30 m chain.

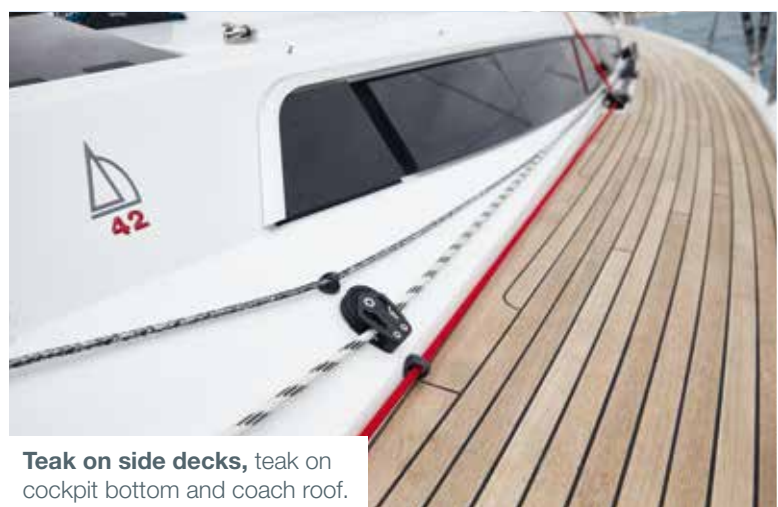

Teak on side decks, teak on cockpit bottom and coach roof.

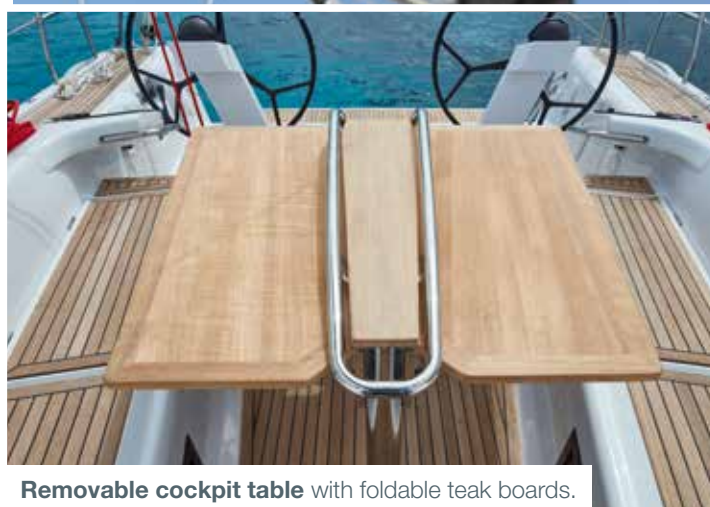

Removable cockpit table with foldable teak boards.



Side deck and bottom anti-slip in White Grey RAL 7047.



Halyard bags.



Composite bowsprit with integrated anchor fitting.

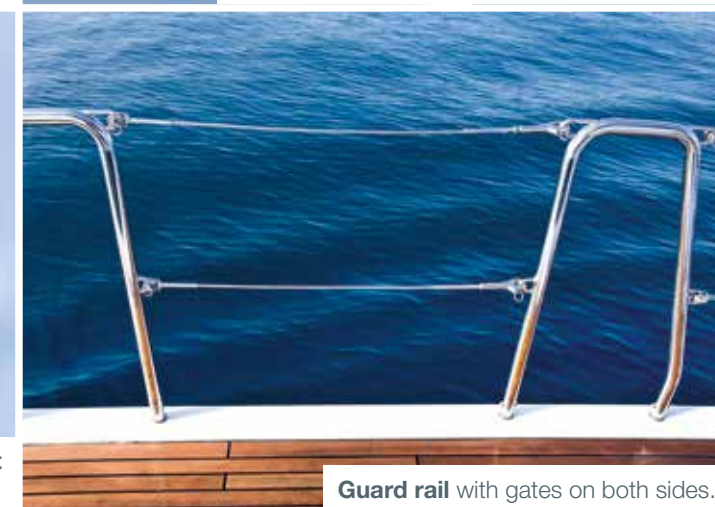

Guard rail with gates on both sides.



Cockpit upholstery.

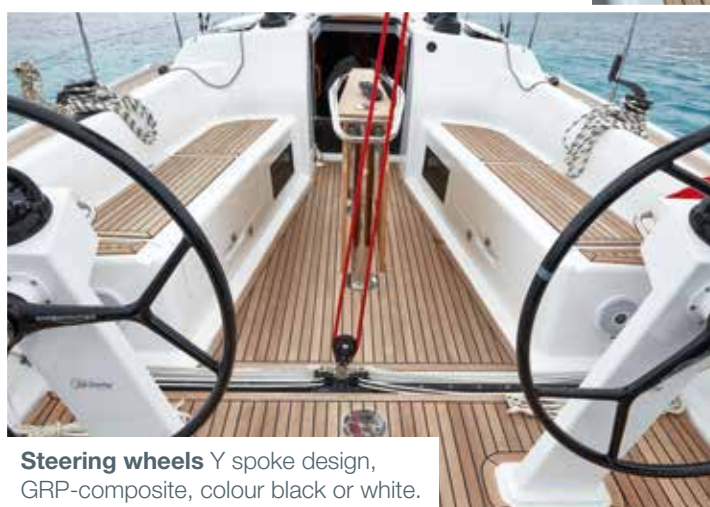

Steering wheels Y spoke design, GRP-composite, colour black or white.

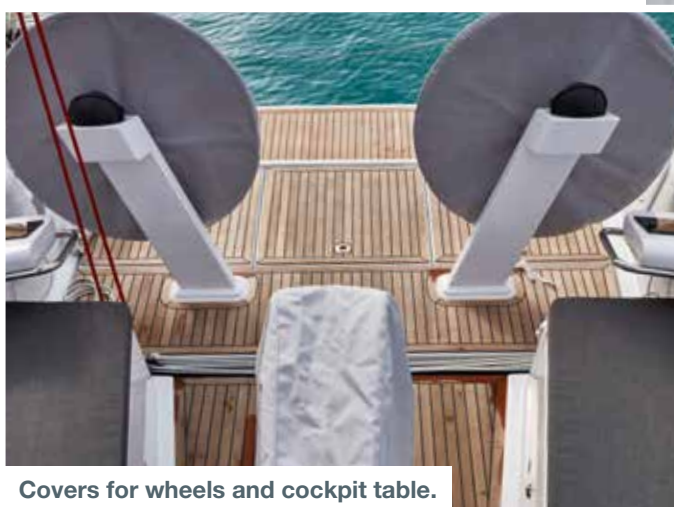

Covers for wheels and cockpit table.



Retractable bow thruster.



2 halyard winches, LEWMAR 45 Race, stb winch electrical.



Spring cleats, retractable.









**Dehler Yachts**

Ladebower Chaussee 11

D-17493 Greifswald

[www.dehler.com](http://www.dehler.com)

Design: [www.smz.de](http://www.smz.de) | Print: Eggert Druckerei & Verlag GmbH | Photos: Nico Krauss, Peter-Paul Reinmuth, HanseYachts AG. This brochure is not contractual. The yachts depicted partly comprise special equipment not included in the standard scope of supply. Illustrations may not correspond with current versions. Subject to alterations in design and equipment without notice and errors excepted.

©2018 HanseYachts AG | CIBD42/E/0918